

GTC-GG1H-72-xxxW & GTC-GG1H-60-xxxW MODULE INSTALLATION MANUAL

1. INTRODUCTION	2
2. DISCLAIMER OF LIABILITY	2
3. REGULATORY INFORMATION.....	2
4. SAFETY GUIDELINES	3
5. INSTALLATION GUIDELINES	4
6. MODULE MAINTENANCE INSTRUCTIONS.....	8

1. INTRODUCTION

This document is general Installation Manual for GTC Glass-Glass, Bifacial 60 and 72 cells module series. Please read this manual completely before transporting, installing, wiring or operation of PV modules in anyway. This manual contains critical safety information for the electrical and mechanical installation of the solar panel. The information in this manual is described on the basis of GTC's knowledge and experience. However, the information and suggestions do not constitute a warranty.

2. DISCLAIMER OF LIABILITY

Installation techniques, handling and use of this product are beyond GTC's control; therefore, GTC does not assume responsibility for loss, damage or expense resulting from improper installation, handling or use. GTC reserves the right to make changes to the product, the specifications, or this manual without prior notice. GTC does not assume responsibility and expressly disclaims liability for damage, loss, expense arising out of, or in any way connected with installation, operation, use, or maintenance by using this manual. GTC requires the customer to obtain prior written authorization before modules can be returned.

3. REGULATORY INFORMATION

This product meets the [IEC 61215, IEC 61730-1 and IEC 61730-2] certification standard for a maximum system voltage of 1000 V & 1500 V. It is the responsibility of the installer and/or system integrator to ensure compliance with all local electrical codes which may be applicable.

The assembly is to be mounted over a fire resistant roof covering rated for the application (only for non-integral modules or panels.).

GTC-GG1H modules are approved for fire safety and safety class A for the standards IEC 61215 and IEC 61730-1 and IEC 61730-2. Modules qualified for safety in accordance with IEC 61140 meet the requirements for safety class II.

Product Safety Ratings:

Maximum system operating voltage.....: 1000V / 1500 V

Safety application class.....: A

Safety class in accordance with IEC 61140.....: II

Fire safety class.....: A

4. SAFETY GUIDELINES

a. Packing / storage / handling

- GTC packing is a heavy-duty design to carry and protect double glass and frameless panels.
 - Maximum 2 boxes can be stacked on each other.
 - Don't stand, sit and walk on the box
 - Always keep boxes in a dry and flat area.
 - Keep the lead closed during temporary storage
 - Modules are packed on the long edge between EVA foam to avoid stress during loading, shipment and unloading.
 - Slide up or down modules with 2 people minimum. Carry modules from long edges only.
 - Do not handle or touch the modules without gloves.
 - 24 boxes for 72 cells & 30 boxes for 60 cells per 13.5m x 2.5 m truck
 - Weight per box: about 1000kg
 - Make sure to move the bot at a straight angle during loading.
 - If unloading from the short edge of the box, the forklift must be equipped with minimum 2m fork
- Note: boxes can be used again after usage. Keep them in good conditions.

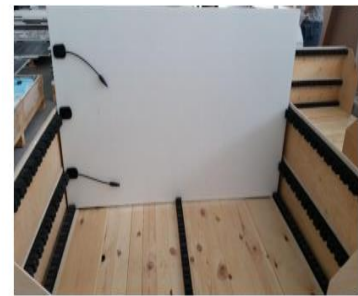

b. Mechanical Safety Precautions :

- GTC modules can only be installed by professional mechanics that have been trained for PV module installation.
- Before the installation, every part of the process should be determined. Every technician should know how to work, which materials are needed and should know his steps of the installation.
- All materials that will be used during the installation should be ready before the installation.
- Do not carry or install PV modules when there are strong winds, rains or bad weather conditions.
- Do not carry metallic items (jewelry, mobile phone, etc.) during installation.
- Do not expose modules to heat, water, gas, corrosive environments, or connect to another electric generator.
- Do not work alone.
- Avoid risk of dropping the modules. Only carry each module by 2 people holding on opposite long edges of the module.
- Do not step, sit, or stand on the module.
- Keep the 3module packed in the box until time of installation.
- Do not place the modules on rough ground. Use styrofoam in between, below and above the modules till complete installation.

- Do not knock or use any nails or screws on or around the modules.
- Avoid scratching the module. Do not place any items on the module.
- Do not attempt to open, drill holes, or change part of module.
- Be especially careful with the glass edges and corners of laminates (frameless modules). Make sure the edges do not touch anything anywhere.
- GTC module is a complete set along with its cables whose integrity should be kept untouched.
- Do not remove the label from the modules at any time.
- Only use modules with the insulation in perfect condition. Broken modules can cause exposed live parts. Never install a damaged module.

c. Electrical Safety Precautions :



- GTC modules come with the sign, , which is a warning that electric current or voltage which can lead to personal injury if you fail to observe the instructions.
- GTC modules can only be installed by professional electricians who have been trained for PV module installation.
- Keep all electrical contacts clear and dry. Do not use wet plugs, cables.
- Do not remove connectors or cables on a module.
- Never try to dismantle or open the junction box of any module. Opening the junction box will void the warranty.
- Ensure that the cable connections do not have cracks, contaminations, or soiling.
- Before you carry out any work on electrical components, disconnect the PV module.
- Match the polarities of cables and terminals when making the connections.
- Do not touch damaged parts with your bare hands.
- Use protective clothing and suitable, insulated tools.
- Only use approved insulated tools for maintenance work on live parts.
- Work in dry conditions. While connecting the module, the electrical connections, the cables and the tools must be all completely dry.
- All electrical connections must be made properly otherwise current leakages may cause sparks with subsequent fatal injuries due to electric shocks and may even cause fires.
- All connectors used in the installed system must comply with code requirements MC4 compatible. Non-compliant connectors may be sources of fire.
- Once connected, solar modules always operate and generate high voltages. Never touch the electrical connections of a solar module under any circumstances, not even if you have disconnected the PV module (photovoltaic module) as there may be a lagged voltage due to earthed connections.

5. INSTALLATION GUIDELINES

a. Mechanical Installation :

- Always carry the GTC modules two or three people holding with two hands evenly apart from the two long edges.
- If the modules come with protection, do not remove the corner protections till modules are mechanically installed in place.
- GTC modules can be installed in various applications on building or free mounting system.
- The right direction and the best tilt of the modules must be determined to obtain maximum yield using proper tools and methods well known in the industry.
- Modules may be installed in portrait or landscape orientation. If the roof has a slope over 10°, then modules should be installed in landscape orientation.
- Artificially concentrated sunlight shall not be directed on the module or panel.
- A minimum 60mm recommended 100 mm clearance between the module and the mounting surface (roof, ground, or other solid surface) is required.

- Clearance between the module and ground should be at least 80 cm at land applications.
- A minimum of 10mm spacing must also be maintained between modules to allow for thermal expansion.
- Holding profiles/purlin should preferably cross the long edges perpendicularly at the backside of the panels.
- Minimum recommended module tilt angle of 5 degrees is required to ensure drainage and enable rain water to keep the glass cleaner at roof applications.
- Professionals that have been trained for PV module installation can only install GTC modules.
- It is recommended to install 72-cell module with at least 4 pieces of 20 cm GTC-made portable frames (6 recommended) that fit the glass-to-glass. However, in case the GTC-made portable frame length is 10cm in the project, it is recommended to use 6 for the 60 cell module.

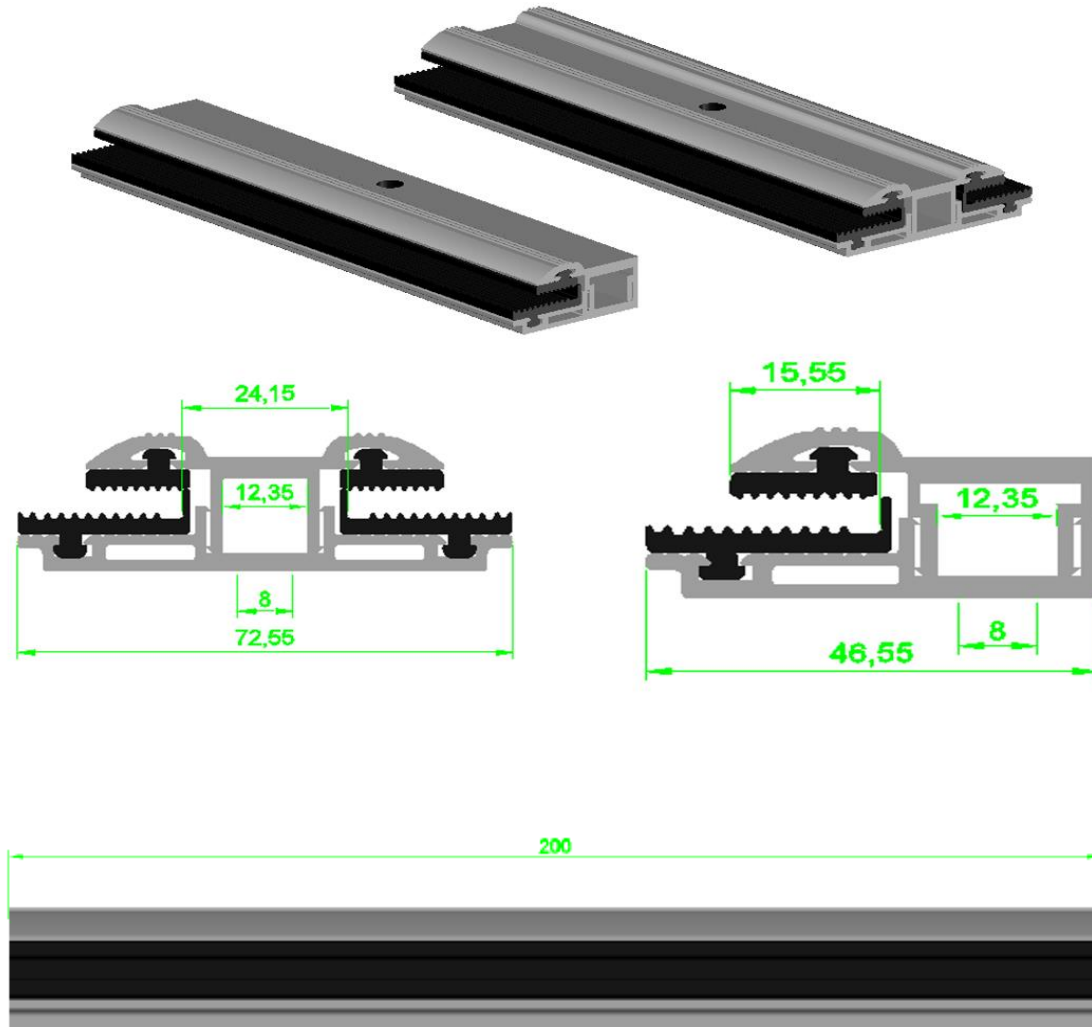
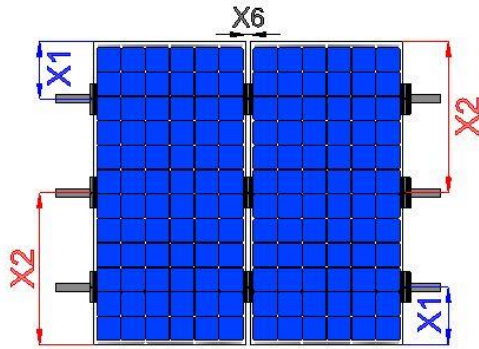
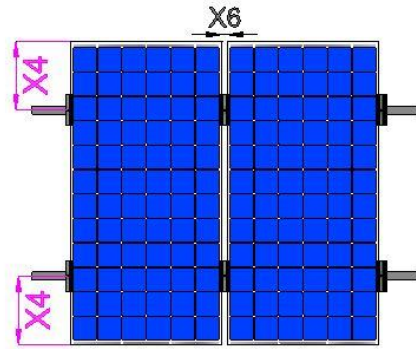

Figure1 : 200 mm single ve double asymmetrical portable frames (mm)

Type-A



Type-B



Type-C

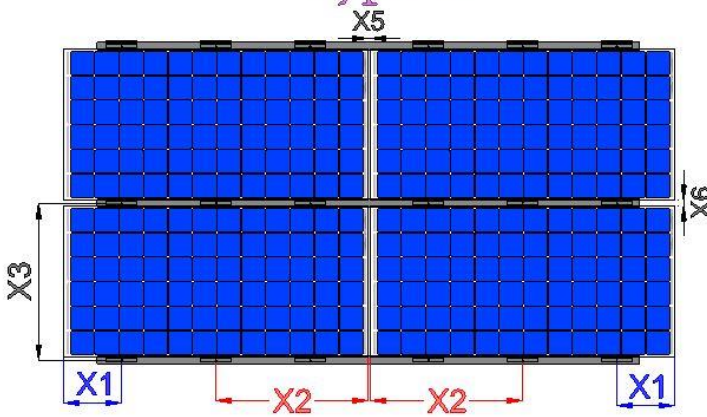

Type-D

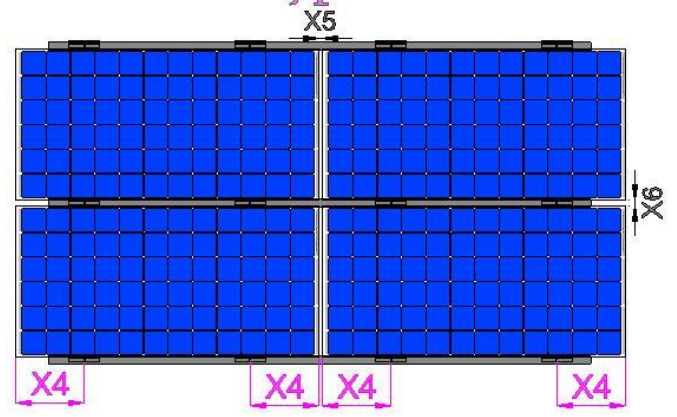

Type	GG1H-60 (1000V)	GG1H-60 (1500V)	GG1H-72 (1500V)	GG1H-72 (1000V)
Dimension(mm)	1665 x 1000	1670 x 1000	1992 x 1000	1987 x 1000
X1 (mm)	200 ~ 250	200 ~ 250	350 ~ 375	350 ~ 375
X2 (mm)	832.5 ± 10	835 ± 10	996 ± 10	993.5 ± 10
X4 (mm)	350 ~ 375	350 ~ 375	410 ~ 450	410 ~ 450
X5 (mm)	20	20	20	20
X6 (mm)	25	25	25	25

Glass / Glass Thickness (Front / Back)	Maximum Load (Pa) (Front / Back) 2 x 200mm Portable Frames	Maximum Load (Pa) (Front / Back) 3 x 200mm Portable Frames
	2 mm + 2 mm	1200 / 1200
2.5 mm + 2.5 mm	2400 / 2400	5400 / 2400
2 mm + 3 mm	2400 / 2400	5400 / 2400

- EPDM (Ethylene Propylene Dianene Monomere) type of material should be covering the inside of the portable frame completely including the inner back and the two pieces (bottom and top) of portable frames should be tied together with a screw.
- Tighten the bolts to secure portable frames to rail for a torque value 20Nm.
- Maintenance must be done regularly to maintain this torque of 20 Nm throughout the lifetime of the solar plant
- A minimum of 10 mm spacing must always be maintained between modules to allow for thermal expansion and for safety of modules.
- Check that the mechanical connections are clean, securely fitted and properly insulated from corrosion risks.

b. Electrical Installation

- Professional electricians who have been trained for PV module installation can only install GTC modules.
- GTC recommends maximum 20 panels in series and 1 in parallel modules configuration for 72 cells modules and 24 panels in series and 1 in parallel modules configuration for 60 cells modules in 1000V PV systems.
- GTC recommends maximum 27 panels in series and 1 in parallel modules configuration for 72 cells modules and 33 panels in series and 1 in parallel modules configuration for 60 cells modules in 1500V PV systems.
- When stringing the modules, make sure that the modules have the same electrical properties.
- Temperature coefficients of the modules as per their label should be used to get a correct prediction of module voltage under temperature variations in order to a proper string size for each inverter used.
- Do not connect the modules together to create a voltage higher than the permitted maximum system voltage.
- GTC modules come with MC4 compatible connectors and must be connected properly according to code requirements to other modules via compatible connectors.
- Never remove connectors or cables of a module.
- Plug in the connector tightly and make sure that the wiring works properly.
- The string ends must be connected by properly sized and code certified DC cables to code specified DC compiler box.
- If there is no suitable DC connector for the inverter to be used, then shoe should be used for the connection.
- Connection input should be made according to the connection type of the inverter to be used.
- It is absolutely necessary to use shoes in connection inputs of AC.
- All cables and connectors should be UV protected and weather resistant -40 °C to 90°C, and rated for maximum allowed system voltage.
- All cables and connectors used for installation should be insulated from severe weather conditions and meet IEC 61730 standard requirements.
- Recommended DC string wire is minimum 4 mm² preferably 6 or 10 mm² cross-sections for minimization of cable losses. Only code certified cables should be used.
- Check that the electrical connections are clean, securely fitted and properly intact.
- All cables and connections should be covered with conduits. This ensures protection of cables from external factors (weather conditions, physical impacts etc.)
- Extreme care must be given for dimensioning the strings for each inverter installed. Voc increase as per ambient temperature decrease must be accounted for in sizing the strings.
- GTC modules have a maximum allowed system voltage rating of (1500 V) Volts DC. All electrical cables and connectors used in the system must be code certified for same voltage rating.
- GTC modules do not have exposed conductive parts and do not require grounding. Other components of the system must be made properly with correct dimension and choice of wires and grounding rod.

- Avoid lightning strike. Place a properly sized and designed lightning rod or Faraday cage or rolling sphere in order to protect the whole system against excessive current exposure.
- Under normal conditions, a PV module is likely to experience conditions that produce more current and/or voltage than reported as standard test conditions. Accordingly, the values of I_{sc} and V_{oc} marked on this module should be multiplied by a factor of 1,25 when determining component voltage ratings, conductor current ratings, fuse sizes, and size of controls connected to the PV output.
- Modules with a suspected electrical problem should be returned to GTC for inspection and possible repair or replacement as per the warranty conditions provided by GTC.

6. MODULE MAINTENANCE INSTRUCTIONS

- Depending on the ambient conditions, modules can lose output as they are likely to accumulate dirt or soil over time. Clean the component if necessary. We recommend water based cleaning of the modules.
- Do not use detergents on the modules surface. Aggressive chemicals cleansers should not be used on cleaning the module.
- Do not dry clean the modules. It may cause scratches on the modules.
- Maintenance must be done regularly to maintain this torque of 20 Nm throughout the lifetime of the solar plant.